



ELECTRALITE

ADJUSTABLE FIRE RATED DOWNLIGHT

V2 - 23/08/18

Before You Begin

- Unpack all components onto a flat surface that will not damage them or allow them to become dirty
- Check that all components are correct and present
- Familiarise yourself with the product, its component parts and how it is assembled.
- Keep all packaging until after a successful installation and retain the instructions for future reference

WARNING: Not suitable for mounting on normally flammable surfaces (e.g. polystyrene tiles and wood based materials)

WARNING: Before proceeding, make sure the ceiling light is switched OFF and the electricity is switched OFF at the mains supply board

Suggested tools required for installation process as follows:

- Screwdriver - with insulated handle.
- Pliers - for twisting wire and cutting cable
- Drill – choose appropriate drill bits for your chosen location and mounting surface



SPECIFICATION:

- Suitable for 30 & 60 minutes fire resistant standard ceiling constructions
- Protection against electric shock: Class I (Earthed)
- Material: Die Cast Steel
- PTFE Cable
- Lamp Type: GU10 220-240V ~ 50Hz 50W MAX
- Dimensions: Overall: 108mm, Diameter: 93 mm Cut Out 85mm
- Minimum Distance from illuminated object: 0.5m
- Complies with BS EN60598, BS5250, BS476 Parts 20, 21 & 23.

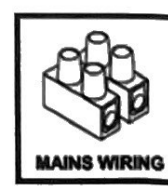
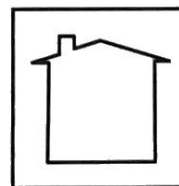

INSTALLATION INSTRUCTIONS:

1. Ensure mains supply is switched off; choose a location for your new fitting. Ensure a minimum of 105mm is available, and ensure there at least 100mm of free space around and 50mm above the luminaire, do not cover the luminaire with thermal insulation.
2. Make a 85mm round fixing hole. Ensure that the hole is cut correctly, we recommend using a circular hole cutter. Take great care not to damage the decorative finish.
3. Make the electrical connections to the terminal block.
4. Remove the bulb retaining clip built into the cover this will allow access to the lampholder, fit the bulb and replace the bulb retaining clip/cover.
5. Lift both spring clips upwards and insert into the 85mm ceiling hole, allow the long ends of the spring clips to pass through the hole and the short ends of the spring clips to engage with the ceiling.
6. Press the fitting firmly into place until it is retained by the spring clips
7. Restore the power supply and switch on.

IF IN DOUBT ABOUT FITTING THIS PRODUCT, PLEASE CONSULT A QUALIFIED ELECTRICIAN

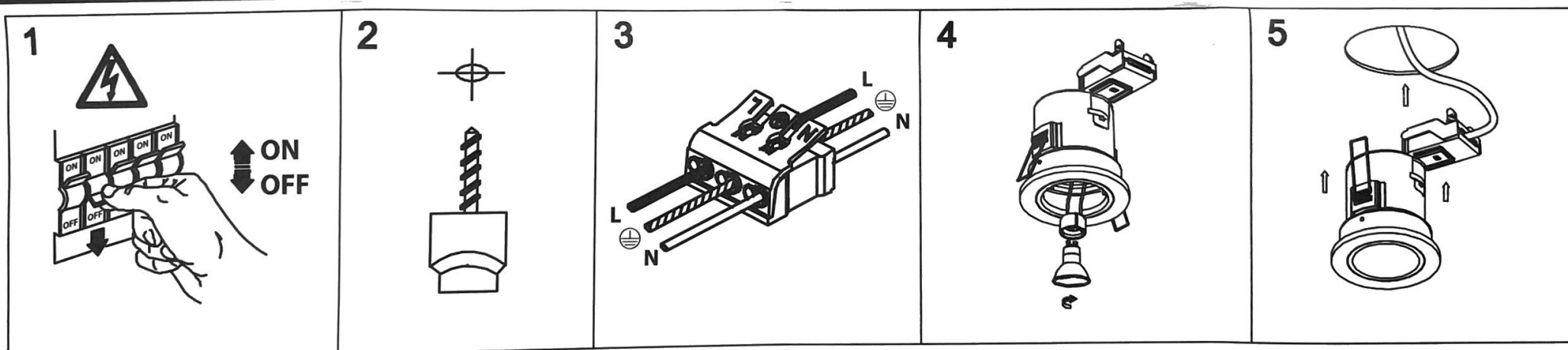

HELPLINE

If you receive this item with parts broken or missing, please telephone: 0333 0050077

Please have ready your name, address, tel. no., product reference, where purchased and parts required.

An answering service is in operation outside office hours and during busy periods.

We regret that we are unable to give advice on internal house wiring.

Cascade Holdings Ltd, Gorse Mill, Gorse Street, Chadderton, Oldham. OL9 9RJ